

Sección
E: 1/4

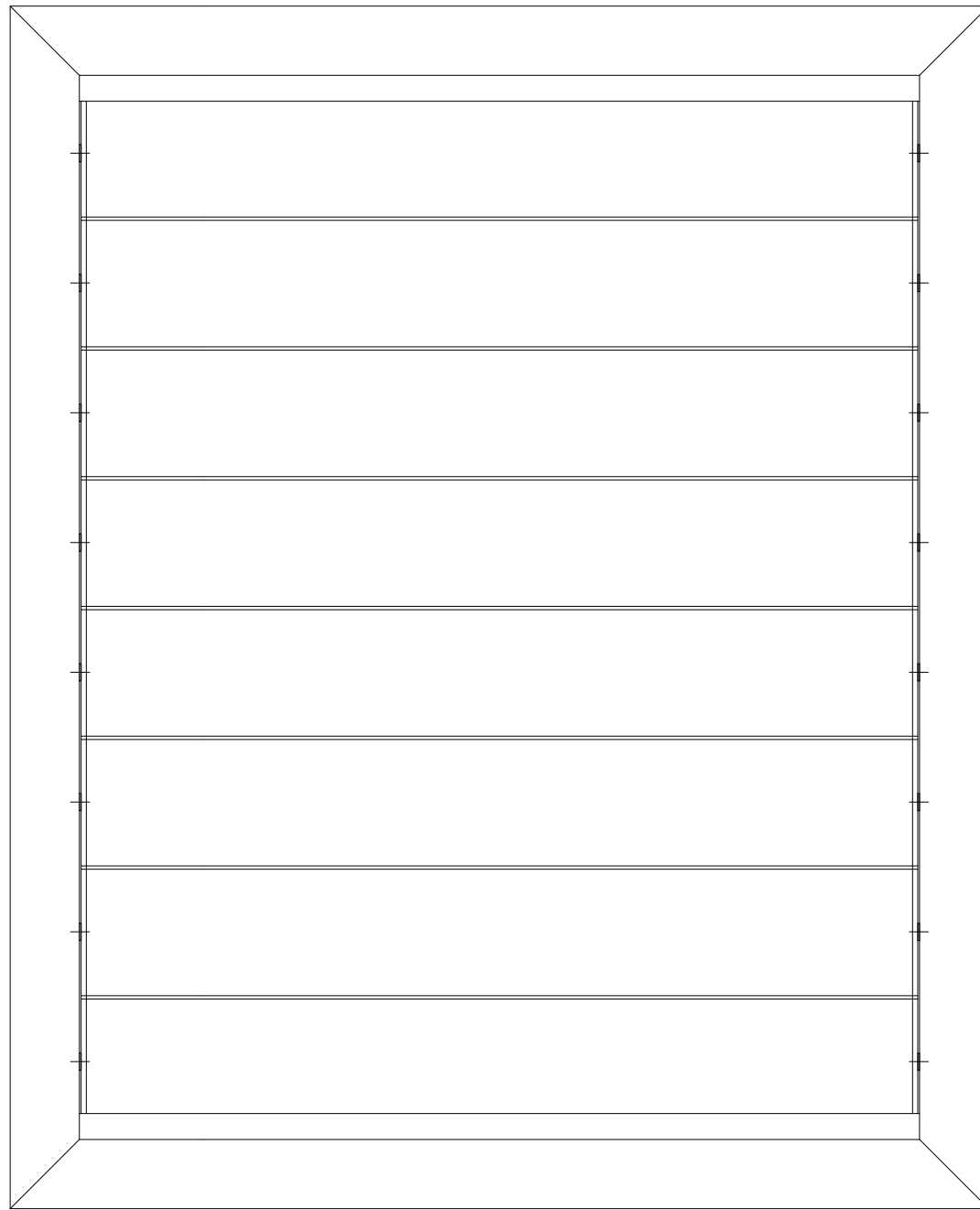

Alzado
E: 1/4

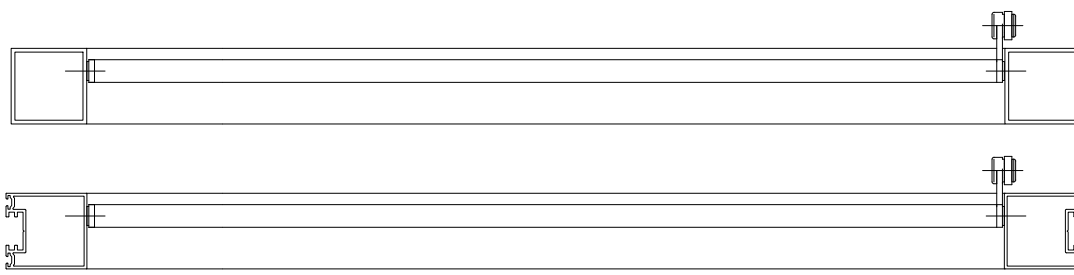

Planta
E: 1/4











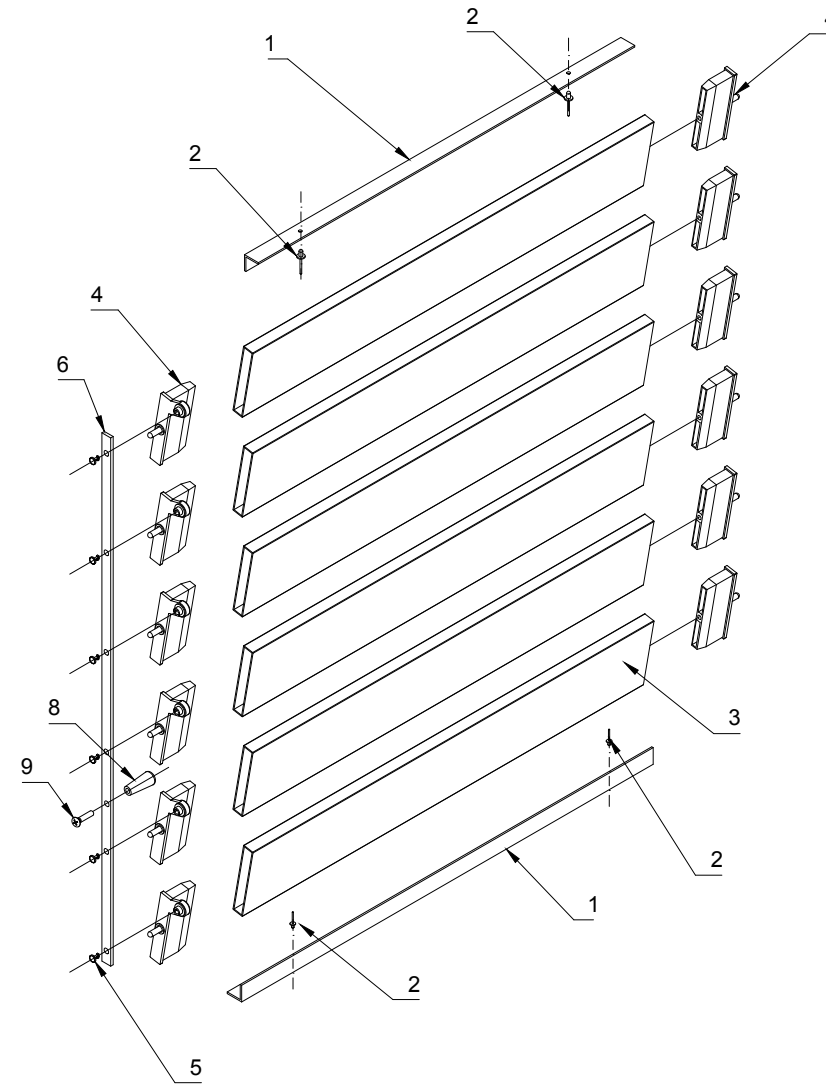

Figura Denominación

-  1 Ángulo 15x15
Ángulo 25x15
-  2 Remache ciego c/plana 3,2x8
-  3 Lama GP E77
-  4 Portalistón oreja izquierda con pivote fijo
Portalistón oreja derecha con pivote fijo
 Portalistón libre con pivote retractil
-  5 Clip fijación portalistones GP-120
-  6 Regle.
-  7 Portalistón oreja derecha accto. motor.
Portalistón oreja izquierda accto. motor.
-  8 Tirador
-  9 Tornillo tirador

Descripción:

Conjunto E 77

 **Aplicación:**
Marco Fijo



Título plano:

CONJUNTO E 77
Marco Fijo

Familia:

CELOSÍAS

Clasificación:

GRADPANEL > Aluminio >
> Serie E > E 77

Autor: GRADHERMETIC
Industrial Gradhermetic, S.A.E.

Escala: Según plano (DIN-A3)

Revisión: v1